

SWISS TURN LATHE

XM20



Specification

Model	XM20	XM20 Y2	XM20 Y2 + B	
NC	Fanuc 32iB Plus	Fanuc 32iB Plus	Fanuc 32iB Plus	
Maximum machining diameter (mm)	Ø20 (Ø25 Op.)	Ø20 (Ø25 Op.)	Ø20 (Ø25 Op.)	
Main				
Z1 stroke (mm)	Guide Bush	205	205	205
	Non Guide Bush	55	55	55
Main spindle	RPM	10,000	10,000	10,000
	Motor power	2.2 / 3.7	2.2 / 3.7	2.2 / 3.7
Turning tool	No of tool	□12 x 6	□12 x 6	□12 x 6
Front tool	No of tool	ER16 x 3 (fix)	ER16 x 3 (fix)	ER16 x 3 (fix)
	No of tool	ER16 x 7 (4 + 3)	ER16 x 7 (4 + 3)	ER16 x 3
Cross drill (Modular)	RPM	6,000	6,000	6,000
	Motor power	2.5	2.5	2.5
B-axis	No of tool	-	-	ER11 x 8
	RPM	-	-	8,000
Sub				
Sub spindle	RPM	10,000	10,000	10,000
	Motor power	2.2 / 3.7	2.2 / 3.7	2.2 / 3.7
Back tool	No of tool	4 (2Fix + 2Driven)	8 (4Fix + 4Driven)	8 (4Fix + 4Driven)
	Fix : ER16 Driven : ER11	RPM	9,000	9,000
	Motor power	1.0	1.0	1.0
Size (L x W x H) (mm)	2,160 x 1,200 x 1,900	2,160 x 1,200 x 1,900	2,160 x 1,200 x 1,900	
Weight (kg)	2,900	2,950	3,000	
Power consumption *	3kVA (Rated : 7kVA)	3kVA (Rated : 7kVA)	3kVA (Rated : 7kVA)	
Cable size	10SQ	10SQ	10SQ	
Air pressure (Liter/Min)	62	62	62	

* Power consumption may vary upon machining condition or attached options.
* Specifications indicated in this catalog may change without prior notice.

Dimension (mm)

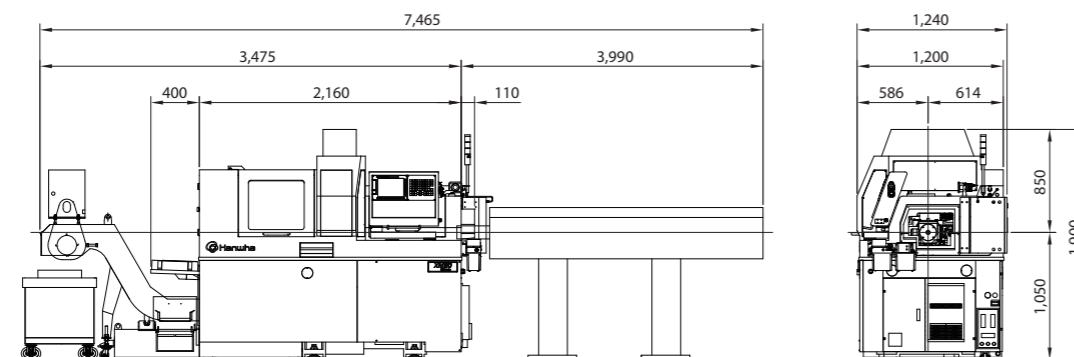

Swiss Turn Lathe

XM20

eXcellent Medical **Dental**



Swiss Turn Lathe

XM20

Powerful 7-axis automatic lathe specialized in stability and taper surface roughness required in the dental market

Minimized thermal displacement by high-rigidity compact size design

- Improved surface roughness and tool life by applying high-performance, high-efficiency 2.5kW cross motor and NC 32iB Plus for machining difficult-to-cut material such as titanium
- High-rigidity, high-performance Back Y2 tool post (9,000RPM) for sub process
- Applied High-rigidity integrated B-axis tool post as standard
- Compatibility with various optional tools (4x modular, back cross, 3-axis live tool, etc.)
- Short working distance and improved convenience by optimizing the equipment structure

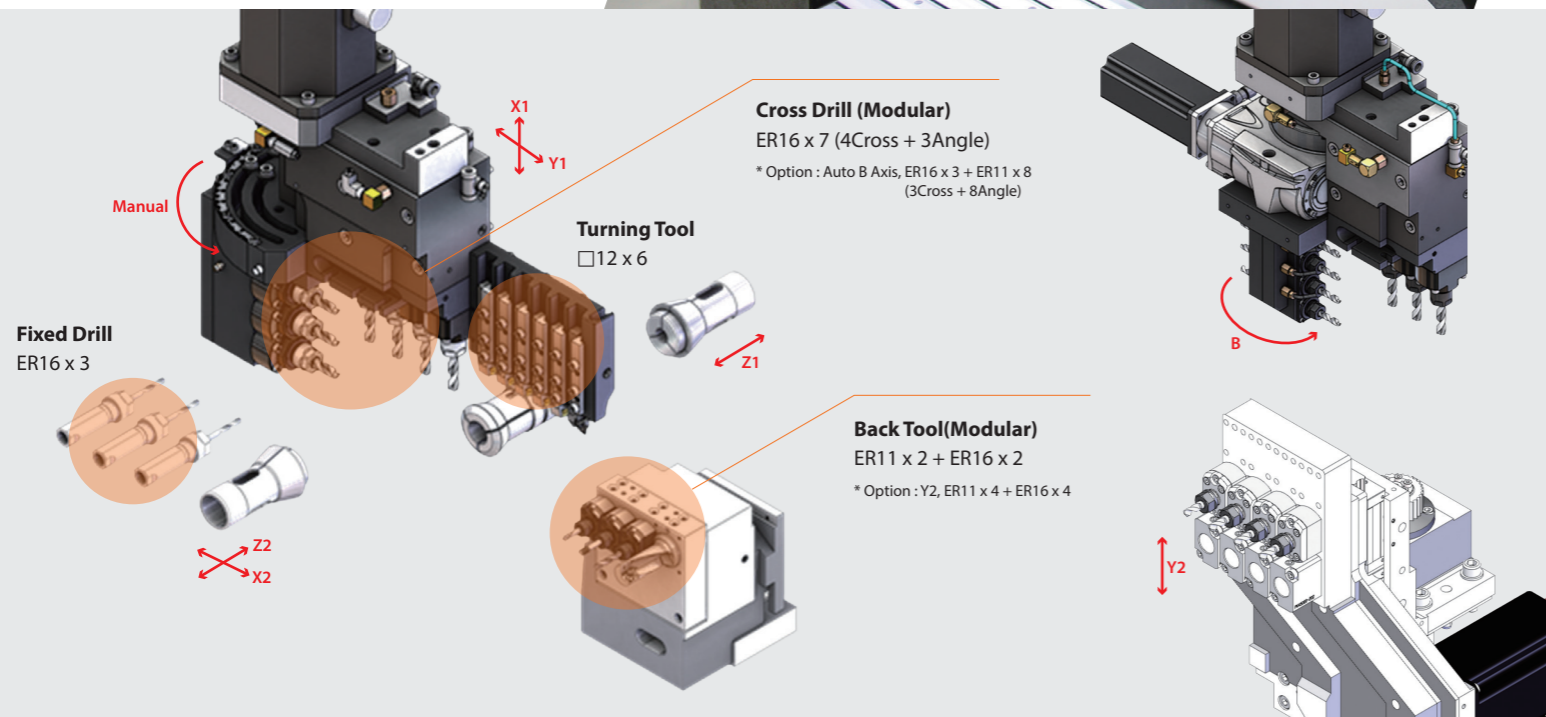
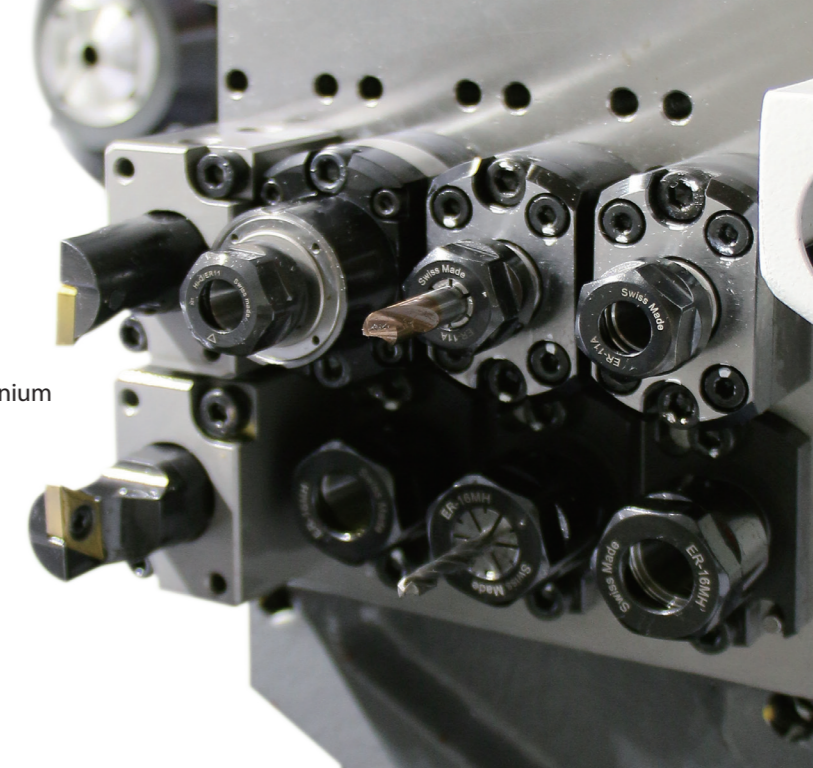
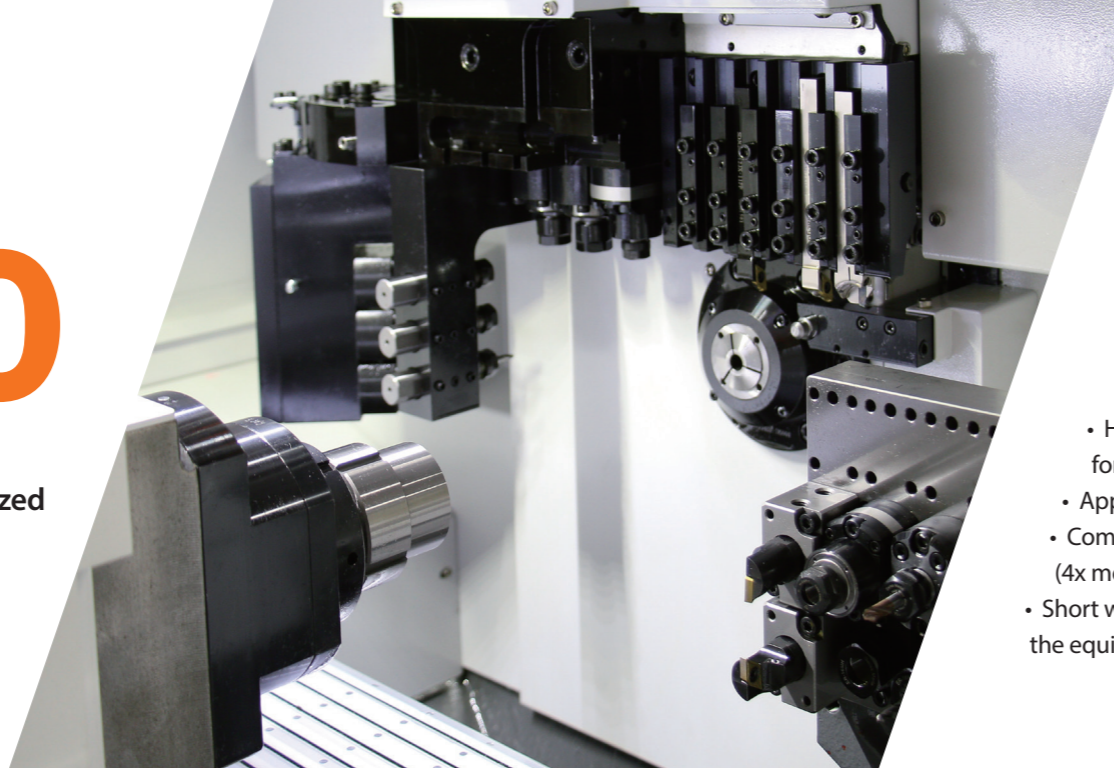

eXcellent Medical Dental CASE STUDY



Precise and stable automatic lathe

- Low-vibration structure specialized for dental product roughness (high-attenuation bed structure applied)
- Enhanced stroke precision and durability
- Structure to minimize thermal deformation (Cooling jacket integrated spindle, lightweight tool post)
- Excellent taper processing roughness by improving working parallelism



- Integrated B-axis tool post as standard
- High precision LM and B/S applied
- Sub-attached 3-axis front tool applied as standard

Convenient and economical equipment

- Reduce maintenance costs by sharing major consumables (chuck, holder, modular, option tool)
- Chip pan and tank that are easy to remove chips
- Cover structure considering convenience of maintenance (chucking section, sub spindle, cable bear, etc.)
- Apply the latest energy saving technology to achieve high energy efficiency

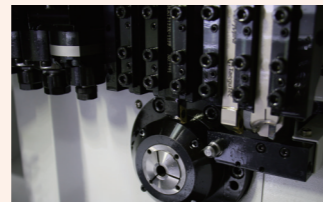

- Mechanical cut off detector as standard
- NH (convertible guide bush) as standard
- Design for nozzle and tool setting

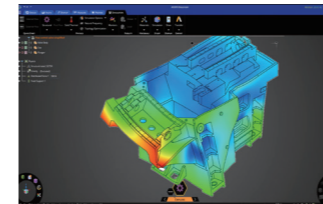

- Adopted High-rigidity, low-vibration rib structure with the latest CAE technology
- Enhanced precision and durability of movement by optimizing casting thickness

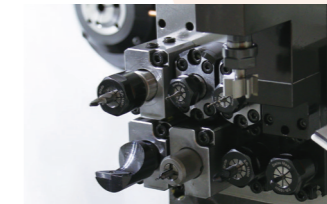

- High rigidity Y2 structure with excellent physical properties
- Guide pin is applied on fixed toll for saving replacement time

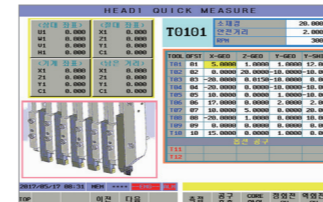

- Tool setting support for beginners (QUICK MEASURE)
- Numeric control automatic chucking force adjustment

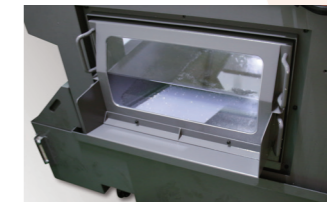

- Improved convenience with mountable window cover
- Large capacity oil tank (208ℓ)